

■ Features

- $V_{DS}=20V$
- $I_D=5.0A$
- $R_{DS(ON)}=25m\Omega @ V_{GS}=4.5V, I_D=5.0A$
- $R_{DS(ON)}=35m\Omega @ V_{GS}=2.5V, I_D=4.0A$

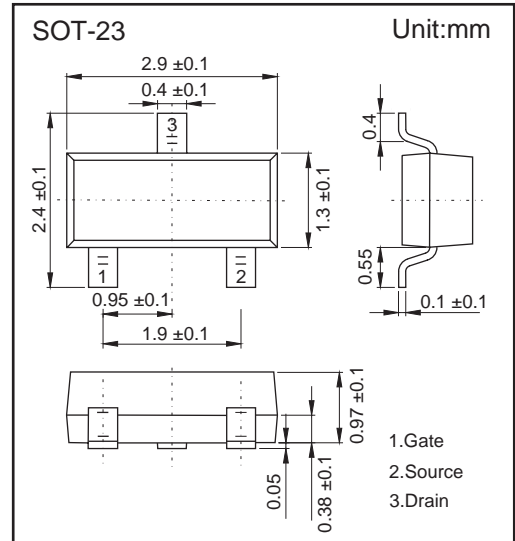
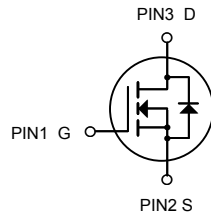

■ Absolute Maximum Ratings $T_a = 25^\circ C$

Parameter	Symbol	Rating	Unit
Drain-Source Voltage	V_{DS}	20	V
Gate-Source Voltage	V_{GS}	± 12	
Continuous Drain Current $T_j=125^\circ C$	I_D	5.0	A
Pulsed Drain Current	I_{DM}	15	
Power Dissipation	P_D	1.25	W
Thermal Resistance.Junction- to-Ambient	R_{thJA}	100	$^\circ C/W$
Junction Temperature	T_J	150	$^\circ C$
Storage Temperature Range	T_{stg}	-55 to 150	

■ Electrical Characteristics Ta = 25°C

Parameter	Symbol	Testconditions	Min	Typ	Max	Unit
Drain-Source Breakdown Voltage	V _{DSS}	V _{GS} =0V, I _D =250μA	20			V
Zero Gate Voltage Drain Current	I _{DSS}	V _{DS} =20V, V _{GS} =0V			1	μA
Gate-Body Leakage	I _{GSS}	V _{GS} =±10V, V _{DS} =0V			±100	nA
Gate Threshold Voltage *	V _{GS(th)}	V _{GS} =V _{DS} , I _D =250μA	0.4	0.7	1.0	V
Drain- Source on-state Resistance *	R _{DS(ON)}	V _{GS} =4.5V, I _D =5.0A		25	34	mΩ
		V _{GS} =2.5V, I _D =4.0A		35	46	mΩ
Forward Transconductance *	g _{FS}	V _{DS} =5V, I _D =5A	5			S
Input Capacitance	C _{ISS}	V _{DS} = 15V, V _{GS} = 0V, f = 1.0MHz		887		pF
Output Capacitance	C _{OSS}			144		pF
Reverse Transfer Capacitance	C _{RSS}			115		pF
Turn-On Delay Time	t _{D(on)}			31.8		ns
Rise Time	t _r	V _{DD} =10V, I _D =1A, V _{GS} =4.5V, R _L =10Ω, R _{GEN} =6Ω		14.5		ns
Turn-Off Delay Time	t _{D(off)}			50.3		ns
Fall Time	t _f			31.9		ns
Total Gate Charge	Q _g	V _{DS} = 10V, I _D = 3.5A, V _{GS} = 4.5V		16.8		nC
Gate-Source Charge	Q _{gs}			2.5		nC
Gate-Drain Charge	Q _{gd}			5.4		nC
Drain-Source Diode Forward Current *	I _S				1.25	A
Diode Forward Voltage	V _{SD}	V _{GS} =0V, I _S =1.25A		0.825	1.2	V

* Pulse Test: Pulse Width ≤ 300 μs, Duty Cycle ≤ 2%

■ Typical Characteristics

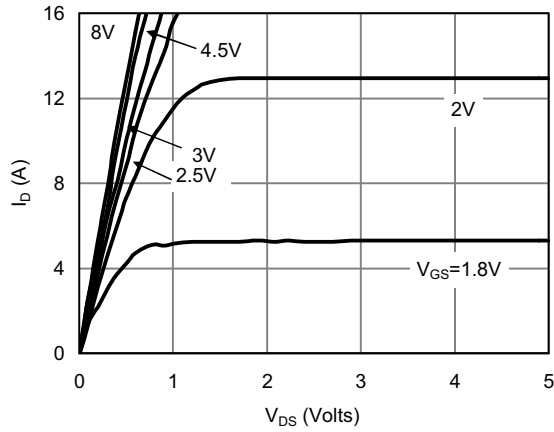

Fig 1: On-Region Characteristics

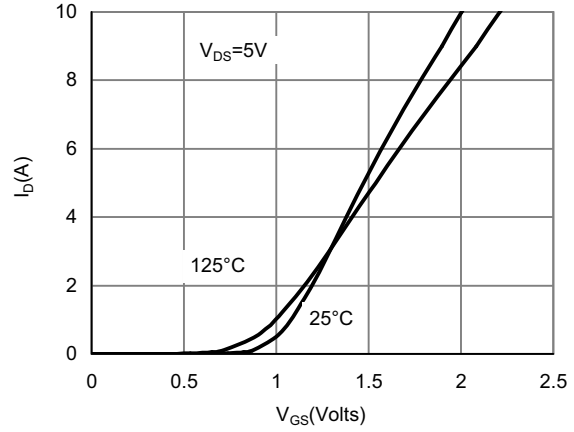

Figure 2: Transfer Characteristics

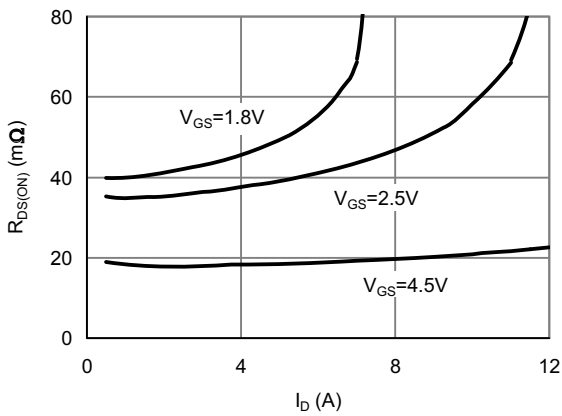

Figure 3: On-Resistance vs. Drain Current and Gate Voltage

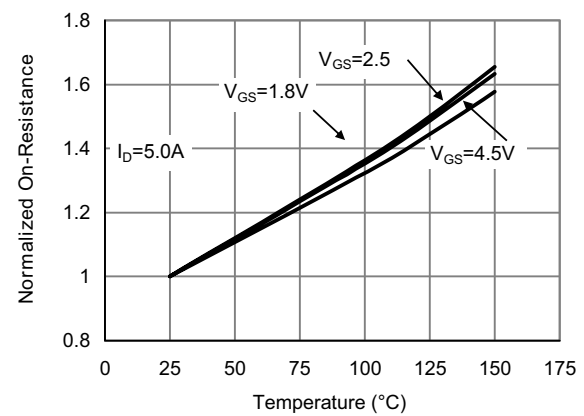

Figure 4: On-Resistance vs. Junction Temperature

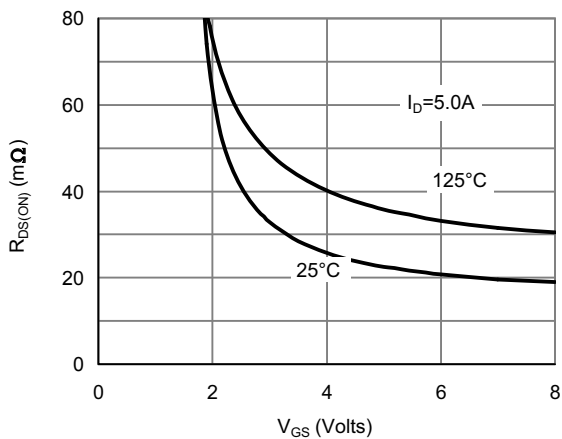

Figure 5: On-Resistance vs. Gate-Source Voltage

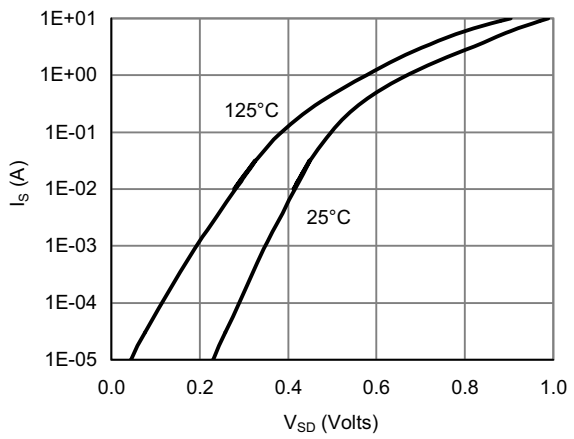

Figure 6: Body-Diode Characteristics